

ASO: The Air Flow Giant.

At 50 Hz 476 cfm of air is forwarded, at 60 Hz 560 cfm. With the appropriate accessories it can supply several Leister air heaters in parallel.

Medium Pressure Blower

ASO

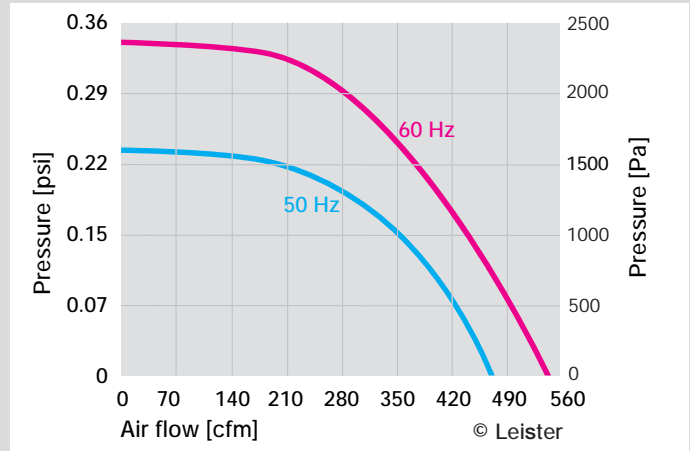

Technical Data ASO

Design radial blower

| Frequency | Hz | 50 | 60 |
|--------------------------------------|----------|--------|--------|
| Air flow (68 °F) | cfm | 476 | 560 |
| Static pressure | psi | 0.23 | 0.35 |
| Max. ambient temperature | °F | 140 | 140 |
| Noise emission level | LpA (dB) | 70 | 70 |
| Environmental protection (IEC 60529) | | IP 54 | IP 54 |
| Outside diameter air inlet | inch | Ø 5.28 | Ø 5.28 |
| Outside diameter air outlet | inch | Ø 3.54 | Ø 3.54 |
| Weight | lb | 33.1 | 33.1 |
| Mark of conformity | | CE | CE |
| Protection classe I | | ⊕ | ⊕ |

Installation Dimensions in inch

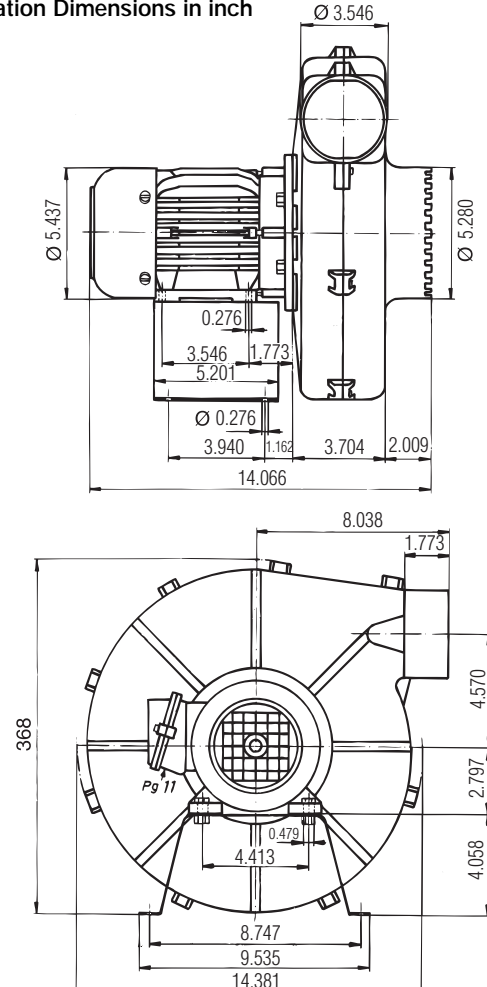

| | | | | |
|------------------------------|-----------|---------|---------------|---------|
| Voltage | V~ 50Hz | 1 × 230 | 3 × 230 / 400 | 3 × 500 |
| | 60Hz | | 3 × 440 – 480 | |
| Power consumption | W | 550 | 550 | 550 |
| Without cable | Order no. | | 103.527 | 103.532 |
| 3 m cable / Euro plug | Order no. | 103.530 | | |

Additional versions on request

Accessories Medium Pressure Blower ASO

(Ø 3.54 inch)

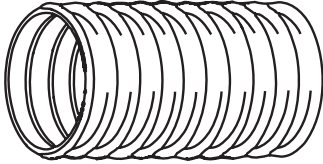
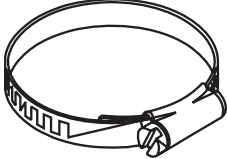
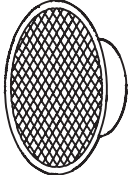
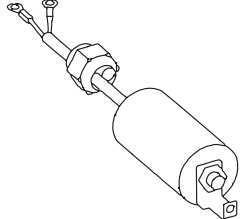
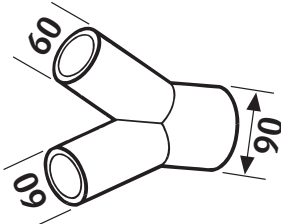
| | | |
|---------|---|--|
| 107.237 |  | PVC air hose 3.54 inch |
| 107.236 |  | Hose clip for Ø3.54 inch air hose |
| 107.239 |  | Stainless steel filter, push-fit on air intake |
| 111.771 |  | Motor capacitor 230 V |
| 107.238 |  | Hose connection adaptor, Push-fit |